

**DAVI**®

EXCELLENCE IN FORMING

[www.davi.com](http://www.davi.com)

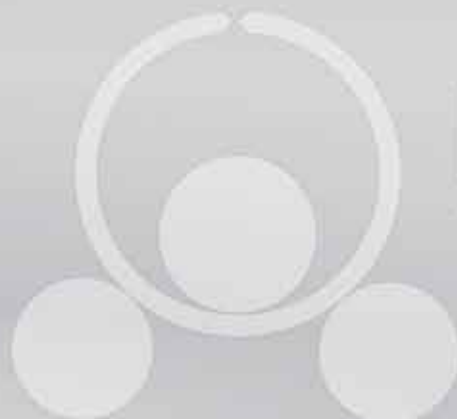

**MAV**  
3 roll DIGITAL

**THE NEW CONCEPT OF QUALITY AND PERFORMANCE**

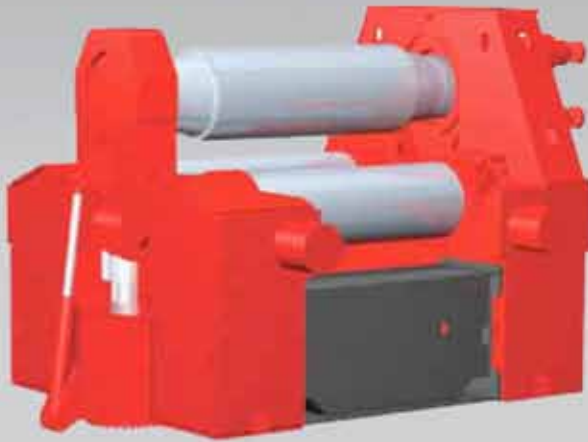

**INDEPENDENT ROLL MOVEMENTS**

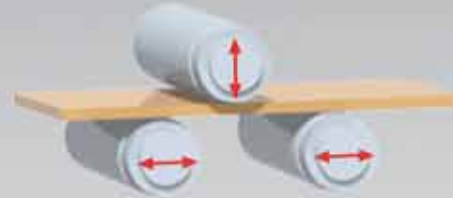

The side rolls geometry allows for an individual horizontal alignment, either symmetric or asymmetric. The top roll moves vertically up and down.

All three rolls move independently one from the other.  
(AND ALL ARE POWER DRIVEN)

**MINIMUM GAUGE**



minimum gauge

The minimum adjustable gauge allows to pre-bend with the minimum flat end, increasing the quality of the finished can.

**BEND THICKER**

A new innovative large geometry, allows to bend thicker cans opening the rolls at maximum gauge, working similar to a press-brake die. It's then possible to increase the bending thickness.

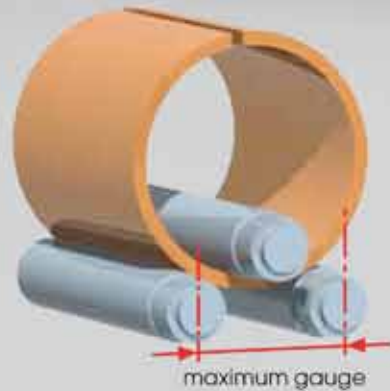

maximum gauge

**THE BEST SOLUTION**

The DAVI MAV is the first plate roll equipped with 3 DRIVEN ROLLS as a standard feature. Each roll, during the rotation, applies full torque to the plate. It's a huge benefit to get the highest precision on the finished cans.



**STRONGER, PRECISE AND MORE RELIABLE...**  
**...New DAVI MAV Plate Roll!**

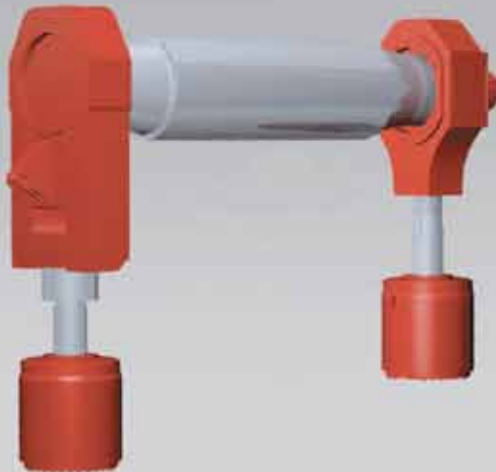

### **SYMMETRICALLY BALANCED LOAD OF THE TOP ROLL**

The top roll is balanced by common bore hydraulic cylinders.  
This ensures a perfect balance of the applied force.

### **INNER FRAMES CYLINDERS**

The hydraulic cylinders of the side rolls are mounted inside the frames (not outside, plenty of screws).  
This allows to apply the full force as the frame retains all the stress.

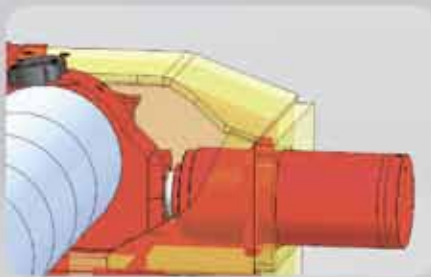

### **HEAVY CONE ROLLING**



The replacement of mechanical brakes with hydraulic motor brakes allows for the two side rolls and the top roll to tilt at a high degree facilitating cone rolling of thick plates.

### **HOT ROLLING**



The 3 roll variable axis is recommended for hot rolling.  
No risk of laminating as no high pinching is applied to the plates during the process.



**STRONGER, PRECISE AND MORE RELIABLE...**  
**...New DAVI MAV Plate Roll!**









**SOLID, COMPACT AND MOST ADVANCED TECHNOLOGY**  
For the best productivity

With 50 years of competence and experience, we engineered an innovative plate roll geometry, with the following advantages:

- The absolute most compact and sturdy design
- Generally increased performances
- Increased life span of the main components, less stressed
- Shallow pits or no pit at all, providing a less expensive solution
- The lowest maintenance need in the plate roll industry





STRONGER,  
PRECISE,  
RELIABLE:  
DAVI MAV  
PLATE ROLL





**STRONGER, PRECISE AND MORE RELIABLE...**  
**...New DAVI MAV Plate Roll!**



## NEW IMPROVED GEOMETRY

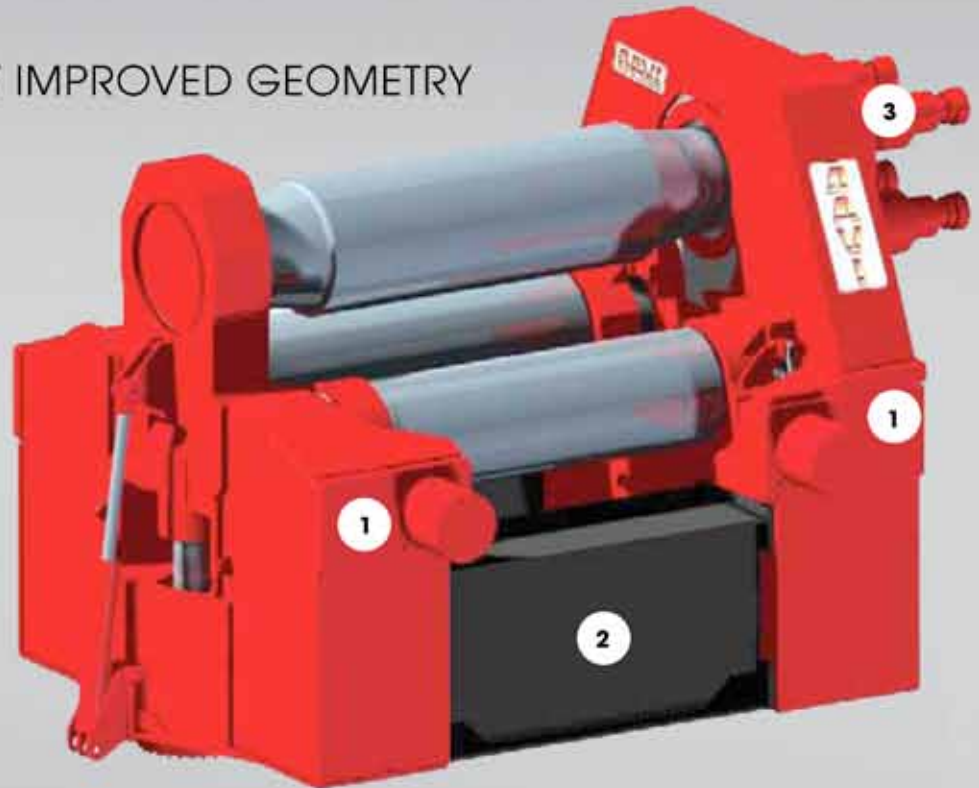

- 1 = New Improved frames
- 2 = New "H" intra-frames base design
- 3 = New coupling on top roll





**SOLID, COMPACT AND MOST ADVANCED TECHNOLOGY**  
For the best productivity

## KNOW-HOW

DAVI engineering has 50 years of technological experience in the heavy plate rolling industry.

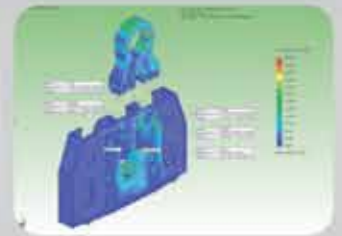

## DAVI UTMOST LEVEL OF QUALITY CONTROL

100% Made in Italy, total quality management (ISO 9001)



## READY FOR IMMEDIATE DELIVERY

Dozens of machines (often more than 100), even those for heavy industries, are finished and ready for immediate delivery. As the production is determined not only on orders received, but for its own inventory, DAVI can offer THE SHORTEST DELIVERY TIME.





**STRONGER, PRECISE AND MORE RELIABLE...**  
**...New DAVI MAV Plate Roll!**



**THE ONLY CUSTOMER CARE IN ROLLING INDUSTRY**

Customer care satisfaction is the DAVI way to conduct business.

Performed by professional, experienced, and specialized customer care Training Team:



**16** qualified and dedicated service engineers worldwide



DAVI Customer Care provides the following services:

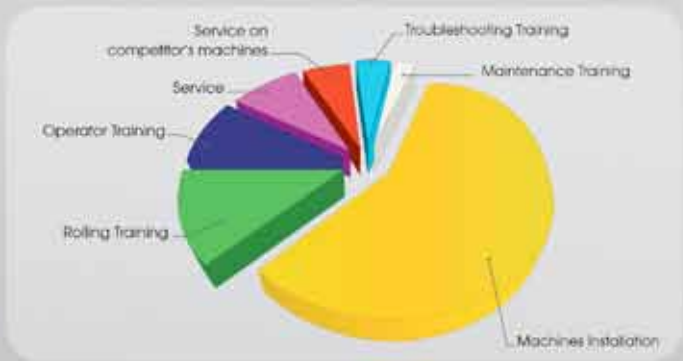

**11.000 PARTS ON SHELF**

More than 11.000 parts are available on shelf, in one of the largest Logistic Center of the fabricating machine industry, are used for machines production or, if needed, as spare parts, to be shipped **ON SAME-DAY BASIS** to our clients.



**DAVI iRoll: MAKES IT ALL!**







DAVI provides 3 and 4 roll plate rolls with capacity in thickness up to 400 mm and in width up to 12 mt, suitable for any application. Plate rolls can be equipped with many different accessories, to provide the most ergonomic and productive solutions, such as: in-feed conveyors, front, side and vertical supports for large diameters. DAVI provides the most advanced **AUTOMATION**, with software from the simplest to the most highly technical state of the art systems for plate rolls.

DAVI products portfolio includes high quality angle rolls, the ideal machine for any type of beams, sections and pipes, especially the heaviest.



DAVI partner

**polwelt**

**DAVI**  
EXCELLENCE IN FORMING

UCIMU



PROMAU S.r.l.

Via Civinelli 1150 | 47522 Cesena (FC) ITALY  
Tel. +39 0547 319611 | Fax +39 0547 317850  
davi-sales@davi.com | www.davi.com